

Silicon NPN Phototransistor

Description

BPW96 is a high speed and high sensitive silicon NPN epitaxial planar phototransistor in a standard T-1 $\frac{3}{4}$ (\varnothing 5 mm) package. Due to its water-clear epoxy the device is sensitive to visible and near infrared radiation.

The viewing angle of $\pm 20^\circ$ makes it insensitive to ambient straylight.

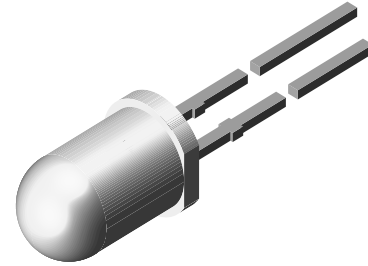

94 8391

Features

- Fast response times
- High photo sensitivity
- Standard T-1 $\frac{3}{4}$ (\varnothing 5 mm) clear plastic package
- Angle of half sensitivity $\varphi = \pm 20^\circ$
- Suitable for visible and near infrared radiation
- Selected into sensitivity groups
- Lead-free component
- Component in accordance to RoHS 2002/95/EC and WEEE 2002/96/EC

Applications

Detector in electronic control and drive circuits

Absolute Maximum Ratings

$T_{amb} = 25^\circ\text{C}$, unless otherwise specified

Parameter	Test condition	Symbol	Value	Unit
Collector Emitter Voltage		V_{CEO}	70	V
Emitter Collector Voltage		V_{ECO}	5	V
Collector current		I_C	50	mA
Collector peak current	$t_p/T = 0.5, t_p \leq 10 \text{ ms}$	I_{CM}	100	mA
Total Power Dissipation	$T_{amb} \leq 47^\circ\text{C}$	P_{tot}	150	mW
Junction Temperature		T_j	100	$^\circ\text{C}$
Storage Temperature Range		T_{stg}	- 55 to + 100	$^\circ\text{C}$
Soldering Temperature	$t \leq 3 \text{ s}$	T_{sd}	260	$^\circ\text{C}$
Thermal Resistance Junction/ Ambient		R_{thJA}	350	K/W

Electrical Characteristics

$T_{amb} = 25^\circ\text{C}$, unless otherwise specified

Parameter	Test condition	Symbol	Min	Typ.	Max	Unit
Collector Emitter Breakdown Voltage	$I_C = 1 \text{ mA}$	$V_{(BR)CEO}$	70			V
Collector-emitter dark current	$V_{CE} = 20 \text{ V}, E = 0$	I_{CEO}		1	200	nA
Collector-emitter capacitance	$V_{CE} = 5 \text{ V}, f = 1 \text{ MHz}, E = 0$	C_{CEO}		3		pF

Optical Characteristics

$T_{amb} = 25\text{ }^{\circ}\text{C}$, unless otherwise specified

Parameter	Test condition	Symbol	Min	Typ.	Max	Unit
Angle of Half Sensitivity		ϕ		± 20		deg
Wavelength of Peak Sensitivity		λ_p		850		nm
Range of Spectral Bandwidth		$\lambda_{0.5}$		620 to 980		nm
Collector Emitter Saturation Voltage	$E_e = 1\text{ mW/cm}^2$, $\lambda = 950\text{ nm}$, $I_C = 0.1\text{ mA}$	V_{CEsat}			0.3	V
Turn-On Time	$V_S = 5\text{ V}$, $I_C = 5\text{ mA}$, $R_L = 100\ \Omega$	t_{on}		2.0		μs
Turn-Off Time	$V_S = 5\text{ V}$, $I_C = 5\text{ mA}$, $R_L = 100\ \Omega$	t_{off}		2.3		μs
Cut-Off Frequency	$V_S = 5\text{ V}$, $I_C = 5\text{ mA}$, $R_L = 100\ \Omega$	f_c		180		kHz

Type Dedicated Characteristics

Parameter	Test condition	Part	Symbol	Min	Typ.	Max	Unit
Collector Light Current	$E_e = 1\text{ mW/cm}^2$, $\lambda = 950\text{ nm}$, $V_{CE} = 5\text{ V}$	BPW96A	I_{ca}	1.5	2.5	4.5	mA
		BPW96B	I_{ca}	2.5	4.5	7.5	mA
		BPW96C	I_{ca}	4.5	8	15	mA

Typical Characteristics ($T_{amb} = 25\text{ }^{\circ}\text{C}$ unless otherwise specified)

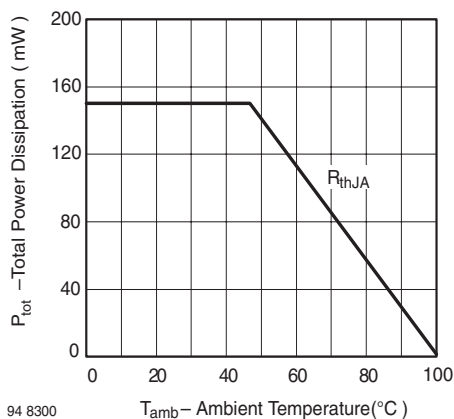

Figure 1. Total Power Dissipation vs. Ambient Temperature

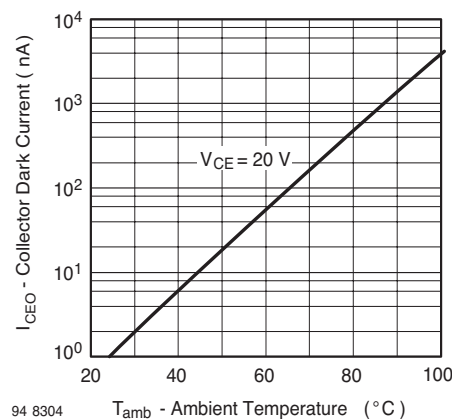

Figure 2. Collector Dark Current vs. Ambient Temperature

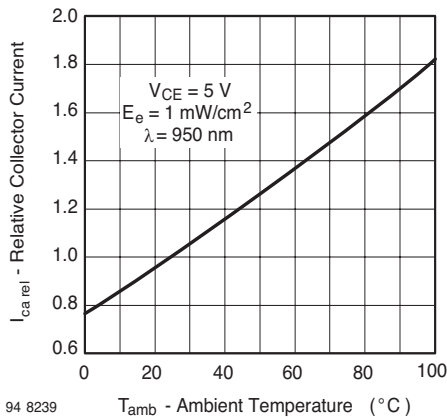

Figure 3. Relative Collector Current vs. Ambient Temperature

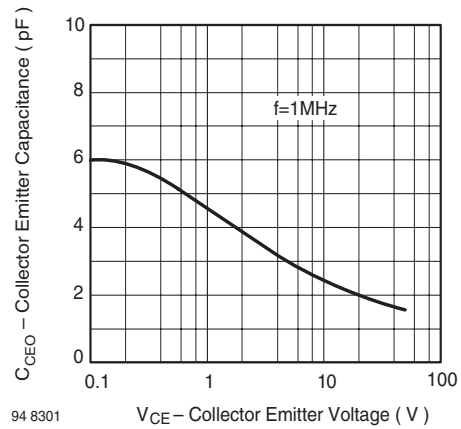

Figure 6. Collector Emitter Capacitance vs. Collector Emitter Voltage

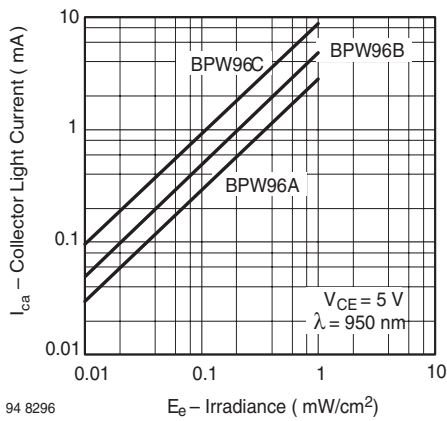

Figure 4. Collector Light Current vs. Irradiance

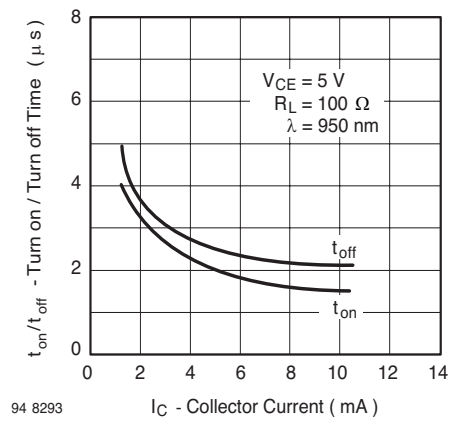

Figure 7. Turn On/Turn Off Time vs. Collector Current

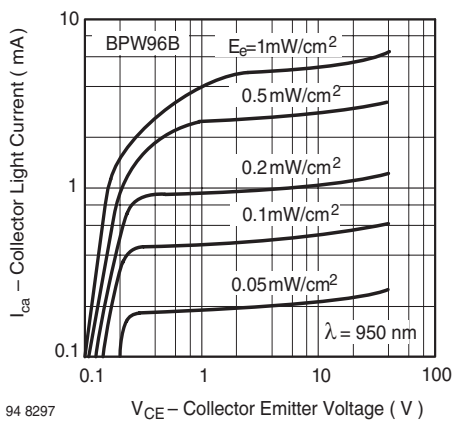

Figure 5. Collector Light Current vs. Collector Emitter Voltage

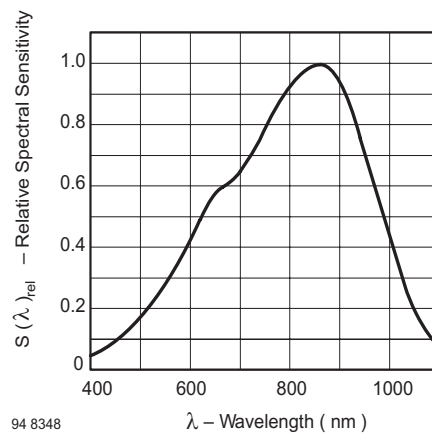
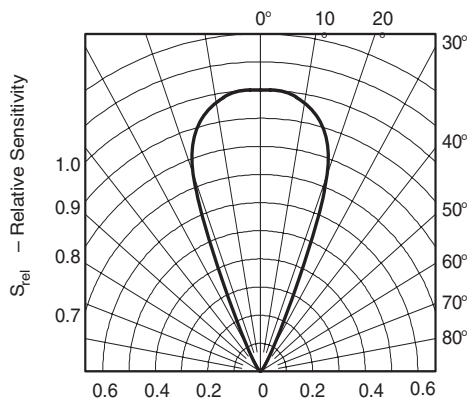

Figure 8. Relative Spectral Sensitivity vs. Wavelength



94 8299

Figure 9. Relative Radiant Sensitivity vs. Angular Displacement

Package Dimensions in mm

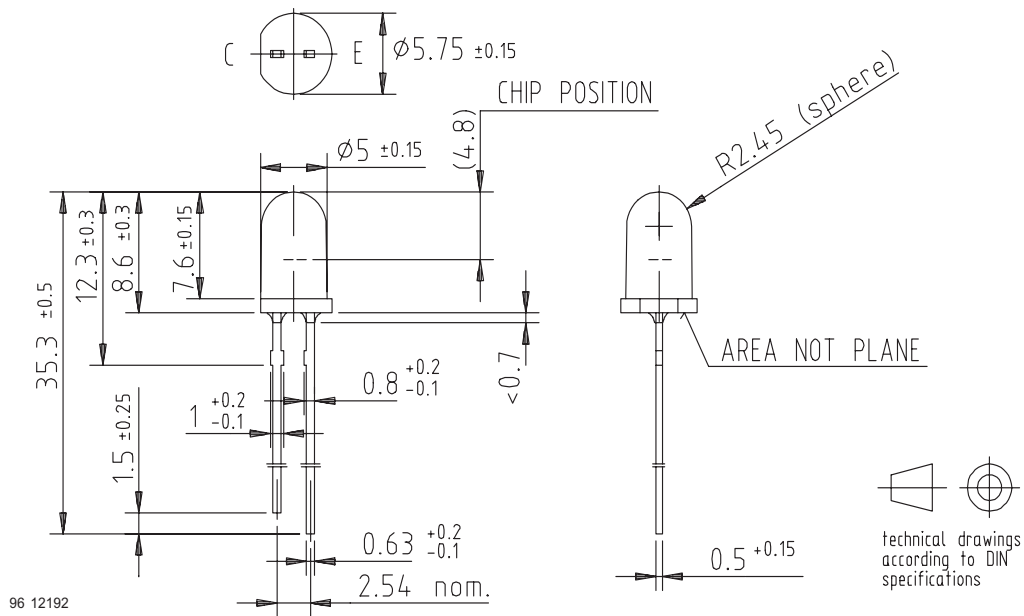

96 12192

Ozone Depleting Substances Policy Statement

It is the policy of Vishay Semiconductor GmbH to

1. Meet all present and future national and international statutory requirements.
2. Regularly and continuously improve the performance of our products, processes, distribution and operating systems with respect to their impact on the health and safety of our employees and the public, as well as their impact on the environment.

It is particular concern to control or eliminate releases of those substances into the atmosphere which are known as ozone depleting substances (ODSs).

The Montreal Protocol (1987) and its London Amendments (1990) intend to severely restrict the use of ODSs and forbid their use within the next ten years. Various national and international initiatives are pressing for an earlier ban on these substances.

Vishay Semiconductor GmbH has been able to use its policy of continuous improvements to eliminate the use of ODSs listed in the following documents.

1. Annex A, B and list of transitional substances of the Montreal Protocol and the London Amendments respectively
2. Class I and II ozone depleting substances in the Clean Air Act Amendments of 1990 by the Environmental Protection Agency (EPA) in the USA
3. Council Decision 88/540/EEC and 91/690/EEC Annex A, B and C (transitional substances) respectively.

Vishay Semiconductor GmbH can certify that our semiconductors are not manufactured with ozone depleting substances and do not contain such substances.

We reserve the right to make changes to improve technical design and may do so without further notice.

Parameters can vary in different applications. All operating parameters must be validated for each customer application by the customer. Should the buyer use Vishay Semiconductors products for any unintended or unauthorized application, the buyer shall indemnify Vishay Semiconductors against all claims, costs, damages, and expenses, arising out of, directly or indirectly, any claim of personal damage, injury or death associated with such unintended or unauthorized use.

Vishay Semiconductor GmbH, P.O.B. 3535, D-74025 Heilbronn, Germany
Telephone: 49 (0)7131 67 2831, Fax number: 49 (0)7131 67 2423



Notice

Specifications of the products displayed herein are subject to change without notice. Vishay Intertechnology, Inc., or anyone on its behalf, assumes no responsibility or liability for any errors or inaccuracies.

Information contained herein is intended to provide a product description only. No license, express or implied, by estoppel or otherwise, to any intellectual property rights is granted by this document. Except as provided in Vishay's terms and conditions of sale for such products, Vishay assumes no liability whatsoever, and disclaims any express or implied warranty, relating to sale and/or use of Vishay products including liability or warranties relating to fitness for a particular purpose, merchantability, or infringement of any patent, copyright, or other intellectual property right.

The products shown herein are not designed for use in medical, life-saving, or life-sustaining applications. Customers using or selling these products for use in such applications do so at their own risk and agree to fully indemnify Vishay for any damages resulting from such improper use or sale.