

## Silicon PIN Photodiode

### Description

BPW41N is a high speed and high sensitive PIN photodiode in a flat side view plastic package. The epoxy package itself is an IR filter, spectrally matched to GaAs or GaAs on GaAlAs IR emitters ( $\lambda_p = 950 \text{ nm}$ ). The large active area combined with a flat case gives a high sensitivity at a wide viewing angle.

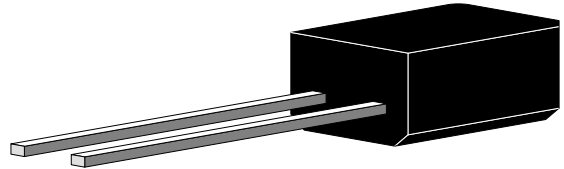

### Features

- Large radiant sensitive area ( $A=7.5 \text{ mm}^2$ )
- Wide angle of half sensitivity  $\phi = \pm 65^\circ$
- High radiant sensitivity
- Fast response times
- Small junction capacitance
- Plastic case with IR filter ( $\lambda=950 \text{ nm}$ )
- Suitable for near infrared radiation

94 8480

### Applications

High speed photo detector

### Absolute Maximum Ratings

$T_{amb} = 25^\circ\text{C}$

| Parameter                           | Test Conditions                 | Symbol     | Value      | Unit             |
|-------------------------------------|---------------------------------|------------|------------|------------------|
| Reverse Voltage                     |                                 | $V_R$      | 60         | V                |
| Power Dissipation                   | $T_{amb} \leq 25^\circ\text{C}$ | $P_V$      | 215        | mW               |
| Junction Temperature                |                                 | $T_j$      | 100        | $^\circ\text{C}$ |
| Storage Temperature Range           |                                 | $T_{stg}$  | -55...+100 | $^\circ\text{C}$ |
| Soldering Temperature               | $t \leq 5 \text{ s}$            | $T_{sd}$   | 260        | $^\circ\text{C}$ |
| Thermal Resistance Junction/Ambient |                                 | $R_{thJA}$ | 350        | K/W              |

### Basic Characteristics

$T_{amb} = 25^{\circ}\text{C}$

| Parameter                      | Test Conditions   | Symbol          | Min | Typ                 | Max | Unit                        |
|--------------------------------|---|-----------------|-----|---------------------|-----|-----------------------------|
| Breakdown Voltage              | $I_R = 100 \mu\text{A}, E = 0$  | $V_{(BR)}$      | 60  |                     |     | V                           |
| Reverse Dark Current           | $V_R = 10 \text{ V}, E = 0$   | $I_{ro}$        |     | 2                   | 30  | nA                          |
| Diode Capacitance              | $V_R = 0 \text{ V}, f = 1 \text{ MHz}, E = 0$                           | $C_D$           |     | 70                  |     | pF                          |
|                                | $V_R = 3 \text{ V}, f = 1 \text{ MHz}, E = 0$                           | $C_D$           |     | 25                  | 40  | pF                          |
| Open Circuit Voltage           | $E_e = 1 \text{ mW/cm}^2, \lambda = 950 \text{ nm}$                     | $V_o$           |     | 350                 |     | mV                          |
| Temp. Coefficient of $V_o$     | $E_e = 1 \text{ mW/cm}^2, \lambda = 950 \text{ nm}$                     | $TK_{V_o}$      |     | -2.6                |     | mV/K                        |
| Short Circuit Current          | $E_e = 1 \text{ mW/cm}^2, \lambda = 950 \text{ nm}$                     | $I_k$           |     | 38                  |     | $\mu\text{A}$               |
| Temp. Coefficient of $I_k$     | $E_e = 1 \text{ mW/cm}^2, \lambda = 950 \text{ nm}$                     | $TK_{I_k}$      |     | 0.1                 |     | %/K                         |
| Reverse Light Current          | $E_e = 1 \text{ mW/cm}^2, \lambda = 950 \text{ nm}, V_R = 5 \text{ V}$  | $I_{ra}$        | 43  | 45                  |     | $\mu\text{A}$               |
| Angle of Half Sensitivity      |   | $\phi$          |     | $\pm 65$            |     | deg                         |
| Wavelength of Peak Sensitivity |   | $\lambda_p$     |     | 950                 |     | nm                          |
| Range of Spectral Bandwidth    |   | $\lambda_{0.5}$ |     | 870...1050          |     | nm                          |
| Noise Equivalent Power         | $V_R = 10 \text{ V}, \lambda = 950 \text{ nm}$                          | NEP             |     | $4 \times 10^{-14}$ |     | $\text{W}/\sqrt{\text{Hz}}$ |
| Rise Time                      | $V_R = 10 \text{ V}, R_L = 1 \text{ k}\Omega, \lambda = 820 \text{ nm}$ | $t_r$           |     | 100                 |     | ns                          |
| Fall Time                      | $V_R = 10 \text{ V}, R_L = 1 \text{ k}\Omega, \lambda = 820 \text{ nm}$ | $t_f$           |     | 100                 |     | ns                          |

### Typical Characteristics ( $T_{amb} = 25^{\circ}\text{C}$ unless otherwise specified)

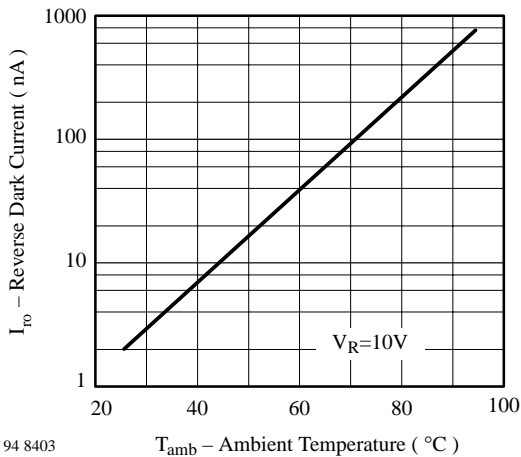

Figure 1. Reverse Dark Current vs. Ambient Temperature

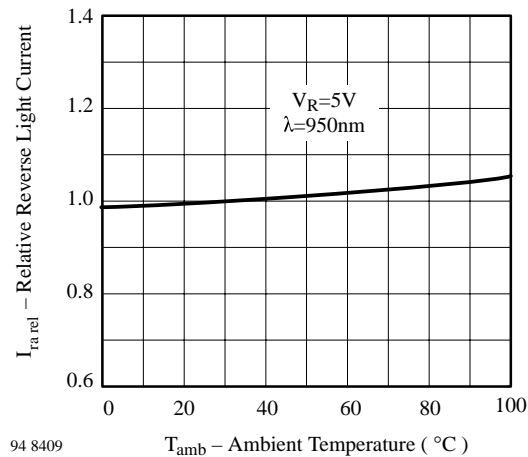
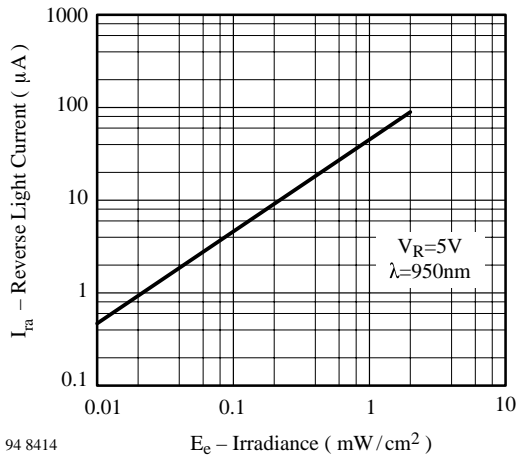
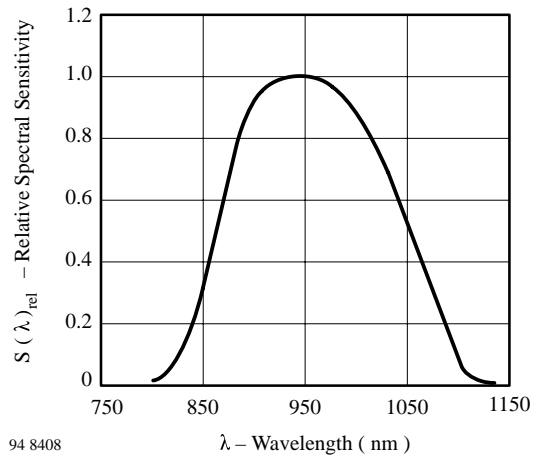

Figure 2. Relative Reverse Light Current vs. Ambient Temperature



94 8414

Figure 3. Reverse Light Current vs. Irradiance



94 8408

Figure 6. Relative Spectral Sensitivity vs. Wavelength

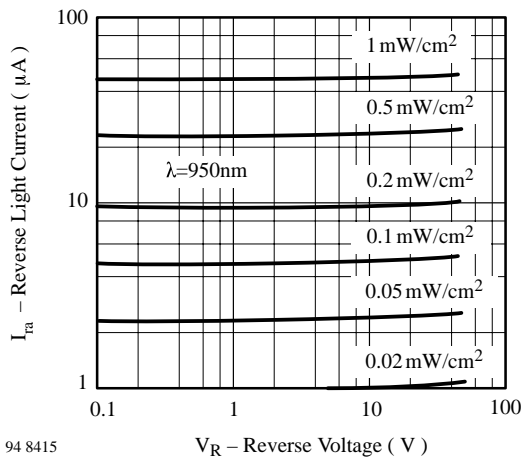

94 8415

Figure 4. Reverse Light Current vs. Reverse Voltage

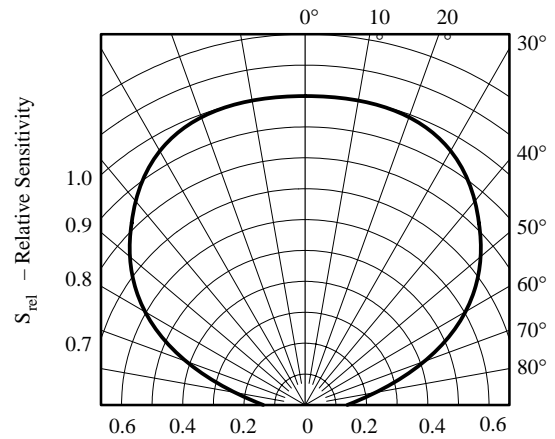

94 8406

Figure 7. Relative Radiant Sensitivity vs. Angular Displacement

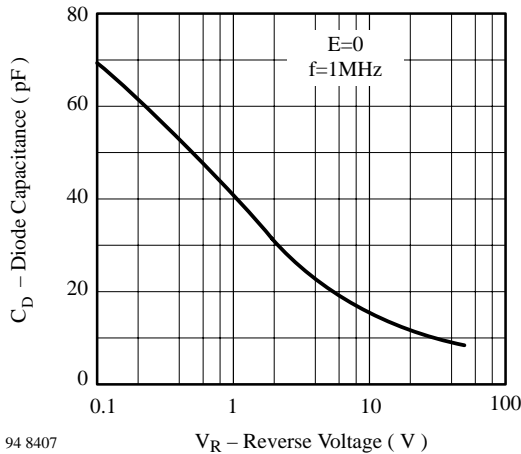

94 8407

Figure 5. Diode Capacitance vs. Reverse Voltage

# BPW41N



Vishay Telefunken

Dimensions in mm

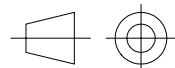
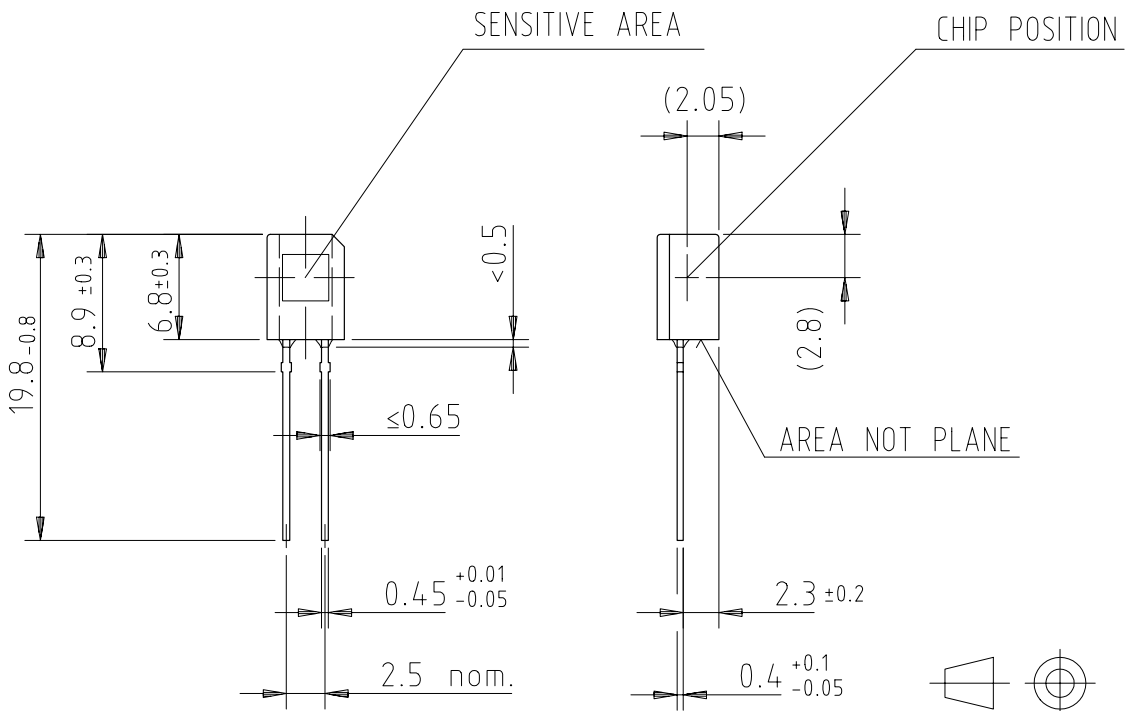
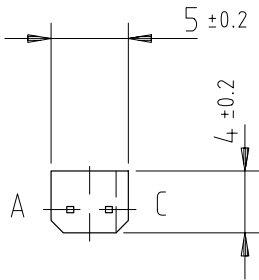

technical drawings according to DIN specifications

96 12195

## Ozone Depleting Substances Policy Statement

It is the policy of **Vishay Semiconductor GmbH** to

1. Meet all present and future national and international statutory requirements.
2. Regularly and continuously improve the performance of our products, processes, distribution and operating systems with respect to their impact on the health and safety of our employees and the public, as well as their impact on the environment.

It is particular concern to control or eliminate releases of those substances into the atmosphere which are known as ozone depleting substances (ODSs).

The Montreal Protocol (1987) and its London Amendments (1990) intend to severely restrict the use of ODSs and forbid their use within the next ten years. Various national and international initiatives are pressing for an earlier ban on these substances.

**Vishay Semiconductor GmbH** has been able to use its policy of continuous improvements to eliminate the use of ODSs listed in the following documents.

1. Annex A, B and list of transitional substances of the Montreal Protocol and the London Amendments respectively
2. Class I and II ozone depleting substances in the Clean Air Act Amendments of 1990 by the Environmental Protection Agency (EPA) in the USA
3. Council Decision 88/540/EEC and 91/690/EEC Annex A, B and C (transitional substances) respectively.

**Vishay Semiconductor GmbH** can certify that our semiconductors are not manufactured with ozone depleting substances and do not contain such substances.

**We reserve the right to make changes to improve technical design and may do so without further notice.**

Parameters can vary in different applications. All operating parameters must be validated for each customer application by the customer. Should the buyer use Vishay-Telefunken products for any unintended or unauthorized application, the buyer shall indemnify Vishay-Telefunken against all claims, costs, damages, and expenses, arising out of, directly or indirectly, any claim of personal damage, injury or death associated with such unintended or unauthorized use.

Vishay Semiconductor GmbH, P.O.B. 3535, D-74025 Heilbronn, Germany  
Telephone: 49 (0)7131 67 2831, Fax number: 49 (0)7131 67 2423