

## Chip Inductors

Japan

Series: **Chip**  
 Type: **RF, RE, ND, NC, NA, FC, FA, FB, SA, PE, PC, PA, EA**

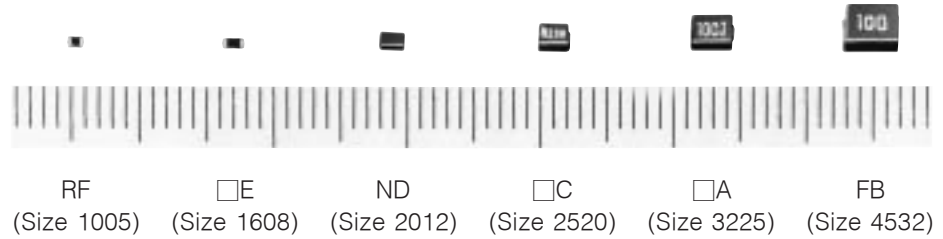

Non winding (RF, □E) and wire wound type chip inductors for automatic mounting and high-density mounting

Industrial Property: Patents 6 (incl. pending)

### ■ Features

- High Q
- Good for mounting
- Wide allowable range (1.0 nH to 1000 μH)

### ■ Recommended Applications

- CTV, VTR, HIC, HDD, FDD, Cordless telephones, Portable telephones  
 Pagers, Video cameras

### ■ Explanation of Part Numbers

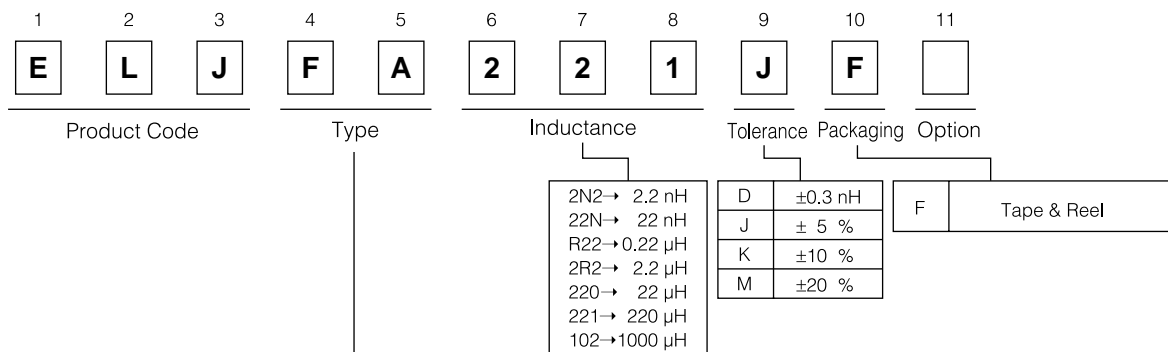

Types \ Styles	F 1005 (0402)	E 1608 (0603)	D 2012 (0805)	C 2520 (1008)	A 3225 (1210)	B 4532 (1812)
	Non Magnetic Core	RF	RE	ND	NC	NA
Regular	-	-	-	FC	FA	FB
Shield	-	-	-	-	SA	-
High Power	-	PE	-	PC	PA	-
Low DC resistance	-	-	-	-	EA	-

Size unit: mm

### Inductance, Size Guide

	Type NAME	L VALUE							Features	
		0.001	0.01	0.1	1.0	10	100	( $\mu$ H) 1000		
Non Magnetic Core	1005 (0402) RF	D		J						
		1.0 nH	6.8 nH	100 nH						
	1608 (0603) RE	D		J						
		1.0 nH	3.9 nH	220 nH						
	2012 (0805) ND	K		J, K						
	10 nH	33 nH	1000 nH							
2520 (1008) NC	K		J, K							
	10 nH	33 nH	820 nH							
3225 (1210) NA	M		K		J					
	0.047 $\mu$ H	0.22 $\mu$ H	1.0 $\mu$ H	8.2 $\mu$ H						
Regular	2520 (1008) FC	K, M		J, K						
		0.22 $\mu$ H	1.0 $\mu$ H	100 $\mu$ H						
	3225 (1210) FA	K, M		J, K						
		0.22 $\mu$ H	1.0 $\mu$ H	220 $\mu$ H						
3225 (1210) SA Mag. shield						K				
	10 $\mu$ H	270 $\mu$ H								
4532 (1812) FB						J, K				
	100 $\mu$ H	1000 $\mu$ H								
High Power	1608 (0603) PE <b>NEW</b>	K								
		2.2 nH	22 nH							
	2520 (1008) PC	M		K						
	1.0 $\mu$ H	6.8 $\mu$ H	33 $\mu$ H							
3225 (1210) PA	M		K							
	1.0 $\mu$ H	10 $\mu$ H	330 $\mu$ H							
Low DC resistance	3225 (1210) EA <b>NEW</b>	M		K						
	1.0 $\mu$ H	10 $\mu$ H	330 $\mu$ H							

Size unit : mm

## 1. Non Magnetic Core Types RF, RE, ND, NC, NA

### Examples : Type 1005(0402)RF

Part No.	Inductance		Q min.	L,Q Test-Freq. (MHz)	Q Typical (800 MHz)	SRF.*1 min.(MHz)	DCR.*2 max.(Ω)	DC current max.(mA)
	nH	Tolerance						
ELJRF1N0DF2	1.0	±0.3 nH	8	100	21	6000	0.05	400
ELJRF1N2DF2	1.2				21	6000	0.06	400
ELJRF1N5DF2	1.5				21	6000	0.07	400
ELJRF1N8DF2	1.8				21	6000	0.08	400
ELJRF2N2DF2	2.2				21	6000	0.09	400
ELJRF2N7DF2	2.7				21	5500	0.10	400
ELJRF3N3DF2	3.3				21	5500	0.12	400
ELJRF3N9DF2	3.9				20	5200	0.15	360
ELJRF4N7DF2	4.7				20	4800	0.17	360
ELJRF5N6DF2	5.6				20	4600	0.19	340
ELJRF6N8JF2	6.8	± 5 %			19	4000	0.30	320
ELJRF8N2JF2	8.2				19	3500	0.35	320
ELJRF10NJF2	10				19	2800	0.41	320
ELJRF12NJF2	12				19	2800	0.45	320
ELJRF15NJF2	15				19	2500	0.60	240
ELJRF18NJF2	18				19	2200	0.70	240
ELJRF22NJF2	22				19	2000	0.80	200
ELJRF27NJF2	27				19	1800	1.2	200
ELJRF33NJF2	33				18	1800	1.4	170
ELJRF39NJF2	39				18	1800	1.7	150
ELJRF47NJF2	47	17	1800	2.1	140			
ELJRF56NJF2	56	17	1500	2.5	130			
ELJRF68NJF2	68	15	1500	4.0	120			
ELJRF82NJF2	82	15	1400	4.5	110			
ELJRF10JF2	100	14	1200	5.5	90			

\*1 : Self Resonant Frequency \*2 : DC Resistance

### Performance Characteristics

Type: 1005 (0402) RF

L vs Frequency Characteristics

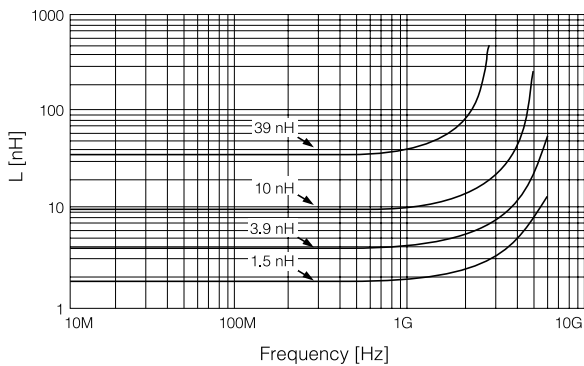

Q vs Frequency Characteristics

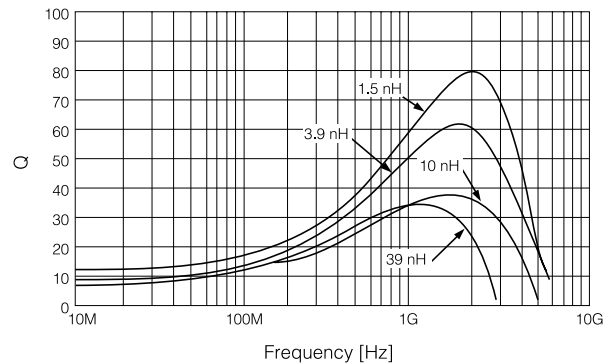

### Examples : Type 1608(0603)RE

Part No.	Inductance		Q min.	L, Q Test-Freq. (MHz)	Q Typical (800 MHz)	SRF*1 min.(MHz)	DCR*2 max.(Ω)	DC Current max.(mA)	
	nH	Tolerance							
ELJRE1N0DF2	1.0	±0.3 nH	7	100	47	6000	0.05	500	
ELJRE1N2DF2	1.2				47	6000	0.06	500	
ELJRE1N5DF2	1.5		47		6000	0.07	500		
ELJRE1N8DF2	1.8		45		6000	0.08	500		
ELJRE2N2DF2	2.2		35		6000	0.09	500		
ELJRE2N7DF2	2.7		35		6000	0.10	500		
ELJRE3N3DF2	3.3		± 5 %		8	35	5500	0.12	500
ELJRE3N9JF2	3.9	9				36	5500	0.15	450
ELJRE4N7JF2	4.7					36	4800	0.17	450
ELJRE5N6JF2	5.6				36	4600	0.18	430	
ELJRE6N8JF2	6.8				36	3550	0.20	430	
ELJRE8N2JF2	8.2				36	3500	0.28	400	
ELJRE10NJF2	10				10	37	2800	0.32	400
ELJRE12NJF2	12					37	2800	0.35	400
ELJRE15NJF2	15	38				2500	0.41	350	
ELJRE18NJF2	18	39				2300	0.45	350	
ELJRE22NJF2	22	40	2000			0.50	300		
ELJRE27NJF2	27	41	2000			0.55	300		
ELJRE33NJF2	33	11	40			1800	0.60	300	
ELJRE39NJF2	39		39			1800	0.80	300	
ELJRE47NJF2	47		38			1800	0.95	250	
ELJRE56NJF3	56		12			35	1800	1.2	250
ELJRE68NJF3	68	35			1500	1.3	250		
ELJRE82NJF3	82	33			1500	1.5	250		
ELJRER10JF3	100	30			1300	1.8	200		
ELJRER12JF3	120	5	25.2		25	1200	3.0	130	
ELJRER15JF3	150				22	1100	4.5	100	
ELJRER18JF3	180				20	1000	6.5	80	
ELJRER22JF3	220			—	900	7.5	70		

\*1 : Self Resonant Frequency \*2 : DC Resistance

### Q-Frequency Characteristics

Type: 1608 (0603) RE

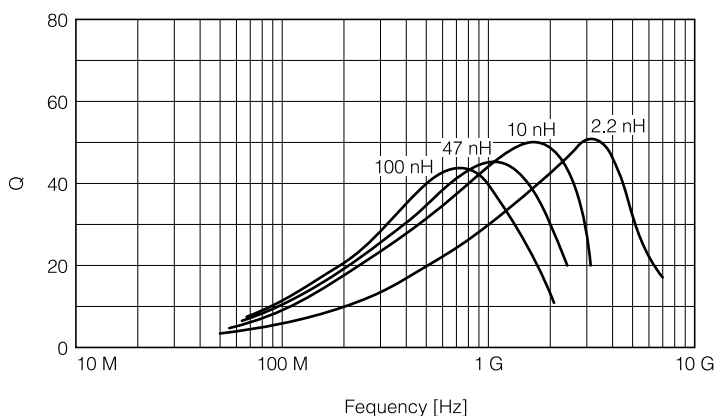

## Examples : Type 2012(0805)ND

Part No.	Inductance		Q min.	L, Q Test-Freq. (MHz)	Q Typical (800 MHz)	SRF*1 min.(MHz)	DCR*2 max.(Ω)	DC Current max.(mA)	
	nH	Tolerance							
ELJND10NKF	10	± 10 %	10	100	72	3300	0.18	540	
ELJND12NKF	12				67	3300	0.24	535	
ELJND15NKF	15				12	73	3000	0.24	520
ELJND18NKF	18					74	3000	0.29	480
ELJND22NKF	22				15	75	2600	0.29	465
ELJND27NKF	27					73	2500	0.34	455
ELJND33NJ/KF	33		80			2050	0.39	395	
ELJND39NJ/KF	39		72			2000	0.41	390	
ELJND47NJ/KF	47		71			1650	0.46	385	
ELJND56NJ/KF	56		63			1550	0.51	360	
ELJND68NJ/KF	68		57		1450	0.57	340		
ELJND82NJ/KF	82		56		1100	0.63	330		
ELJNDR10J/KF	100	± 5 % ± 10 %	8	25.2	51	800	0.86	285	
ELJNDR12J/KF	120				32	600	0.99	275	
ELJNDR15J/KF	150				10	36	600	1.47	230
ELJNDR18J/KF	180					34	600	1.61	195
ELJNDR22J/KF	220					—	500	1.84	170
ELJNDR27J/KF	270					—	300	1.95	165
ELJNDR33J/KF	330		—			200	2.16	160	
ELJNDR39J/KF	390		—			150	2.37	150	
ELJNDR47J/KF	470		—		150	2.56	145		
ELJNDR56J/KF	560		—		100	2.69	140		
ELJNDR68J/KF	680		—		100	3.02	130		
ELJNDR82J/KF	820		—		80	3.38	125		
ELJND1R0J/KF	1000	8	7.96	—	80	3.88	120		

\*1 : Self Resonant Frequency \*2 : DC Resistance

## Q-Frequency Characteristics

Type: 2012 (0805) ND

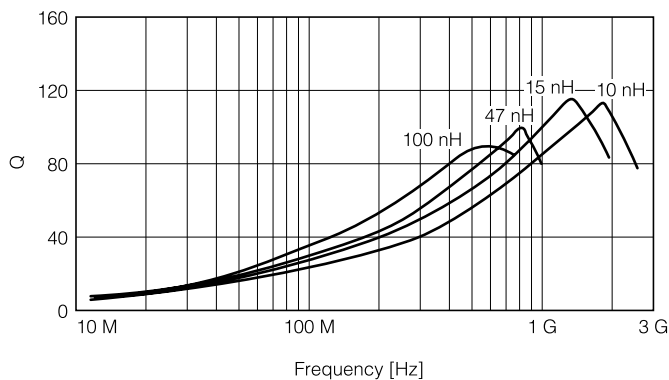

### ■ Examples : Type 2520(1008)NC

Part No.	Inductance		Q min.	L, Q Test Freq.( MHz)	SRF *1 min.(MHz)	DCR *2 max.(Ω)	DC Current max.(mA)		
	nH	Tolerance							
ELJNC10NKF	10	± 10 %	10	100	2500	0.32	280		
ELJNC12NKF	12				2200	0.34	270		
ELJNC15NKF	15				1800	0.38	255		
ELJNC18NKF	18				1550	0.40	250		
ELJNC22NKF	22				1350	0.43	240		
ELJNC27NKF	27	± 10 %	15		1150	0.47	230		
ELJNC33NK/JF	33				1000	0.51	220		
ELJNC39NK/JF	39				890	0.55	215		
ELJNC47NK/JF	47				770	0.59	205		
ELJNC56NK/JF	56				670	0.63	200		
ELJNC68NK/JF	68			590	0.68	190			
ELJNC82NK/JF	82			520	0.73	185			
ELJNCR10K/JF	100			± 10 % ± 5 %	10	25.2	460	0.80	175
ELJNCR12K/JF	120						400	0.87	170
ELJNCR15K/JF	150						340	0.98	160
ELJNCR18K/JF	180	300	1.05				155		
ELJNCR22K/JF	220	260	1.15				145		
ELJNCR27K/JF	270	230	1.25				140		
ELJNCR33K/JF	330	200	1.37				135		
ELJNCR39K/JF	390	180	1.47				130		
ELJNCR47K/JF	470	160	1.58				125		
ELJNCR56K/JF	560	145	1.70				120		
ELJNCR68K/JF	680	130	1.85	110					
ELJNCR82K/JF	820	100	2.10	100					

\*1 : Self Resonant Frequency \*2 : DC Resistance

### ■ Examples : Type 3225(1210)NA

Part No.	Inductance			Q		SRF *1 min.(MHz)	DCR *2 max.(Ω)	DC Current max.(mA)	
	μH	Freq. (MHz)	Tolerance	min.	Freq. (MHz)				
ELJNA47NMF	0.047	100	±20 %	10	100	680	0.20	450	
ELJNA56NMF	0.056					600	0.22	420	
ELJNA68NMF	0.068					540	0.25	400	
ELJNA82NMF	0.082					500	0.27	380	
ELJNAR10MF	0.10					450	0.30	360	
ELJNAR12MF	0.12	25.2	± 10 %		10	25.2	400	0.67	240
ELJNAR15MF	0.15						350	0.72	230
ELJNAR18MF	0.18						320	0.81	220
ELJNAR22KF	0.22						280	0.90	210
ELJNAR27KF	0.27						250	1.0	200
ELJNAR33KF	0.33	1.0	± 10 %	13		7.96	220	1.1	190
ELJNAR39KF	0.39						200	1.2	180
ELJNAR47KF	0.47						180	1.4	175
ELJNAR56KF	0.56						160	1.5	170
ELJNAR68KF	0.68						150	1.7	155
ELJNAR82KF	0.82				135		1.9	145	
ELJNA1R0JF	1.0				120		2.1	125	
ELJNA1R2JF	1.2				110		2.3	120	
ELJNA1R5JF	1.5				95		2.7	115	
ELJNA1R8JF	1.8				85		3.0	110	
ELJNA2R2JF	2.2	80	3.2	110					
ELJNA2R7JF	2.7	70	3.6	105					
ELJNA3R3JF	3.3	62	4.2	100					
ELJNA3R9JF	3.9	57	4.4	95					
ELJNA4R7JF	4.7	52	7.7	70					
ELJNA5R6JF	5.6	46	8.7	65					
ELJNA6R8JF	6.8	42	10	60					
ELJNA8R2JF	8.2	38	11	60					

\*1 : Self Resonant Frequency \*2 : DC Resistance

Design, Specifications are subject to change without notice. Ask factory for technical specifications before purchase and/or use. Whenever a doubt about safety arises from this product, please inform us immediately for technical consultation without fail.

## 2. Normal Types FC, FA, SA, FB

### ■ Examples : Type 2520(1008)FC

Part No.	Inductance		Q min.	L , Q Test Freq.( MHz)	SRF* <sup>1</sup> min.(MHz)	DCR* <sup>2</sup> max.(Ω)	DC Current max.(mA)
	μH	Tolerance					
ELJFCR22M/KF	0.22	±20 % ±10 %		25.2	230	0.70	190
ELJFCR27M/KF	0.27				210	0.75	180
ELJFCR33M/KF	0.33				190	0.85	170
ELJFCR39M/KF	0.39				175	0.95	160
ELJFCR47M/KF	0.47				160	1.0	155
ELJFCR56M/KF	0.56				150	1.1	150
ELJFCR68M/KF	0.68				135	1.25	140
ELJFCR82M/KF	0.82				125	1.4	130
ELJFC1R0K/JF	1.0	±10 % ± 5 %	25	7.96	115	0.65	195
ELJFC1R2K/JF	1.2				100	0.75	180
ELJFC1R5K/JF	1.5				90	0.85	170
ELJFC1R8K/JF	1.8				85	0.95	160
ELJFC2R2K/JF	2.2				80	1.05	155
ELJFC2R7K/JF	2.7				75	1.2	145
ELJFC3R3K/JF	3.3				65	1.3	135
ELJFC3R9K/JF	3.9				60	1.4	130
ELJFC4R7K/JF	4.7				55	1.55	125
ELJFC5R6K/JF	5.6				50	1.75	120
ELJFC6R8K/JF	6.8		45	1.95	115		
ELJFC8R2K/JF	8.2		40	2.2	105		
ELJFC100K/JF	10		20	2.52	32	3.5	80
ELJFC120K/JF	12				30	3.8	75
ELJFC150K/JF	15				28	4.4	70
ELJFC180K/JF	18				25	5.0	65
ELJFC220K/JF	22				22	5.8	60
ELJFC270K/JF	27				21	6.3	115
ELJFC330K/JF	33				20	7.1	110
ELJFC390K/JF	39				18	9.5	90
ELJFC470K/JF	47	17			11.0	80	
ELJFC560K/JF	56	16			12.1	75	
ELJFC680K/JF	68	15	16.6	70			
ELJFC820K/JF	82	13	19.0	65			
ELJFC101K/JF	100	15	0.796	12	21.0	60	

\*1 : Self Resonant Frequency \*2 : DC Resistance

### Examples : Type 3225(1210)FA

Part No.	Inductance		Q min.	L , Q Test Freq.( MHz)	SRF* <sup>1</sup> min.(MHz)	DCR* <sup>2</sup> max.(Ω)	DC Current max.(mA)		
	μH	Tolerance							
ELJFAR22M/KF2	0.22	±20 % ±10 %	25	25.2	230	0.29	360		
ELJFAR27M/KF2	0.27				210	0.32	345		
ELJFAR33M/KF2	0.33				190	0.35	330		
ELJFAR39M/KF2	0.39				175	0.39	305		
ELJFAR47M/KF2	0.47				160	0.44	290		
ELJFAR56M/KF2	0.56				150	0.49	275		
ELJFAR68M/KF2	0.68				135	0.55	260		
ELJFAR82M/KF2	0.82				125	0.61	245		
ELJFA1R0K/JF2	1.0	±10 % ± 5 %	30	7.96	115	0.69	230		
ELJFA1R2K/JF2	1.2				100	0.75	215		
ELJFA1R5K/JF	1.5				90	0.75	210		
ELJFA1R8K/JF	1.8				85	0.82	200		
ELJFA2R2K/JF	2.2				80	0.95	190		
ELJFA2R7K/JF	2.7				75	1.1	180		
ELJFA3R3K/JF	3.3				65	1.2	180		
ELJFA3R9K/JF	3.9				60	1.3	175		
ELJFA4R7K/JF	4.7				55	1.5	165		
ELJFA5R6K/JF	5.6				50	1.6	160		
ELJFA6R8K/JF	6.8				45	1.8	150		
ELJFA8R2K/JF	8.2				40	2.0	140		
ELJFA100K/JF	10				2.52	30	36	2.1	140
ELJFA120K/JF	12						33	2.5	125
ELJFA150K/JF	15						30	2.8	120
ELJFA180K/JF	18						27	3.3	110
ELJFA220K/JF	22		25	3.7			105		
ELJFA270K/JF	27		22	5.0			90		
ELJFA330K/JF	33		20	5.6			85		
ELJFA390K/JF	39		20	6.4			80		
ELJFA470K/JF	47		15	7.0			75		
ELJFA560K/JF	56		15	8.0			70		
ELJFA680K/JF	68		15	9.0			65		
ELJFA820K/JF	82		11	10			60		
ELJFA101K/JF	100		0.796	20			10	10	60
ELJFA121K/JF	120						10	11	55
ELJFA151K/JF	150						8	15	50
ELJFA181K/JF	180						7	17	50
ELJFA221K/JF	220				7	21	45		

\*1 : Self Resonant Frequency \*2 : DC Resistance



## ■ Examples : Type 3225(1210)SA

Part No.	Inductance			Q		SRF*1 min.(MHz)	DCR *2 max.(Ω)	DC Current max.(mA)
	μH	Freq. (MHz)	Tolerance	min.	Freq. (MHz)			
ELJSA100KF	10	1.0	±10 %	40	5.0	30	1.8	18
ELJSA120KF	12					28	2.0	17
ELJSA150KF	15					25	2.2	15
ELJSA180KF	18					23	2.5	13
ELJSA220KF	22					20	2.8	12
ELJSA270KF	27					18	3.2	10
ELJSA330KF	33					17	3.5	10
ELJSA390KF	39				15	3.8	9	
ELJSA470KF	47				14	4.0	8	
ELJSA560KF	56				13	4.5	7	
ELJSA680KF	68				1.5	12	5.0	6
ELJSA820KF	82					11	6.0	6
ELJSA101KF	100					10	7.0	5
ELJSA121KF	120					9	8.0	5
ELJSA151KF	150	5	9.0	5				
ELJSA181KF	180	5	11	5				
ELJSA221KF	220	4	12	5				
ELJSA271KF	270	0.1	4	14	5			

\*1 : Self Resonant Frequency \*2 : DC Resistance

## ■ Examples : Type 4532(1812)FB

Part No.	Inductance			Q		SRF*1 min.(MHz)	DCR *2 max.(Ω)	DC Current max.(mA)
	μH	Freq. (MHz)	Tolerance	min.	Freq. (MHz)			
ELJFB101K/JF	100	0.1	±10 % ± 5 %	40	2.52	6.7	8.8	105
ELJFB121K/JF	120				1.5	6.1	10	100
ELJFB151K/JF	150					5.5	11	95
ELJFB181K/JF	180				5.1	13	85	
ELJFB221K/JF	220				0.796	4.5	13	85
ELJFB271K/JF	270					4.1	14	80
ELJFB331K/JF	330					3.7	16	75
ELJFB391K/JF	390			30	3.3	19	70	
ELJFB471K/JF	470				3.3	31	55	
ELJFB561K/JF	560				2.7	35	50	
ELJFB681K/JF	680				2.5	39	50	
ELJFB821K/JF	820				2.4	45	45	
ELJFB102K/JF	1000				2.1	53	40	

\*1 : Self Resonant Frequency \*2 : DC Resistance

### 3. High Power Types PE, PC, PA

■ examples : Type 1608(0603)PE

Part No.	Inductance		Q min.	L , Q Test Freq.( MHz)	SRF * <sup>1</sup> min.(MHz)	DCR * <sup>2</sup> max.(Ω)	DC Current max.(mA)
	nH	Tolerance					
ELJPE2N2KF	2.2	± 10 %	8	100	6000	0.030	2.1
ELJPE2N7KF	2.7				5500	0.030	2.1
ELJPE3N3KF	3.3				5500	0.040	2.1
ELJPE3N9KF	3.9				5200	0.040	2.1
ELJPE4N7KF	4.7				4800	0.050	2.1
ELJPE5N6KF	5.6				4600	0.055	2.1
ELJPE6N8KF	6.8		4000		0.055	1.9	
ELJPE8N2KF	8.2		3500		0.060	1.7	
ELJPE10NKF	10		2800		0.065	1.4	
ELJPE12NKF	12		2500		0.080	1.3	
ELJPE15NKF	15		2200		0.100	0.9	
ELJPE18NKF	18		2000		0.120	0.8	
ELJPE22NKF	22		1800		0.150	0.7	

\*1 : Self Resonant Frequency \*2 : DC Resistance

■ Examples : Type 2520(1008)PC

Part No.	Inductance		Q min.	L , Q Test Freq.( MHz)	SRF * <sup>1</sup> min.(MHz)	DCR * <sup>2</sup> max.(Ω)	DC Current max.(mA)
	μH	Tolerance					
ELJPC1R0MF	1.0	±20 %	10	7.96	95	0.45	475
ELJPC1R5MF	1.5				85	0.55	435
ELJPC2R2MF	2.2				65	0.65	390
ELJPC3R3MF	3.3		8		55	0.85	340
ELJPC4R7MF	4.7				43	1.2	285
ELJPC6R8KF	6.8				44	1.3	170
ELJPC100KF	10	±10 %	8.5	2.52	32	2.2	210
ELJPC120KF	12				25	2.7	195
ELJPC150KF	15				21	3.2	175
ELJPC220KF	22		20		18	4.0	160
ELJPC330KF	33				16	6.5	120

\*1 : Self Resonant Frequency \*2 : DC Resistance

■ Examples : Type 3225(1210)PA

Part No.	Inductance		Q min.	L , Q Test Freq.( MHz)	SRF *1 min.(MHz)	DCR *2 max.(Ω)	DC Current max.(mA)		
	μH	Tolerance							
ELJPA1R0MF	1.0	±20 %	7	7.96	150	0.15	600		
ELJPA1R5MF	1.5				110	0.18	550		
ELJPA2R2MF	2.2				80	0.23	500		
ELJPA3R3MF	3.3				58	0.28	400		
ELJPA4R7MF	4.7				46	0.34	350		
ELJPA6R8MF	6.8				38	0.42	300		
ELJPA100KF	10	±10 %	15	2.52	23	0.50	240		
ELJPA120KF	12				21	0.60	230		
ELJPA150KF	15				18	0.74	220		
ELJPA180KF	18				17	0.90	205		
ELJPA220KF	22				15	1.15	185		
ELJPA270KF	27				13	1.45	165		
ELJPA330KF	33				12	1.65	155		
ELJPA390KF	39				11	1.90	145		
ELJPA470KF	47				9.5	2.25	135		
ELJPA560KF	56				8.5	3.30	110		
ELJPA680KF	68				7.5	3.70	105		
ELJPA820KF	82				7.0	4.20	100		
ELJPA101KF	100				20	0.796	6.5	5.00	90
ELJPA121KF	120						6.0	7.00	75
ELJPA151KF	150	5.5	8.00	70					
ELJPA181KF	180	5.0	9.50	65					
ELJPA221KF	220	4.0	11.0	60					
ELJPA271KF	270	3.5	14.5	55					
ELJPA331KF	330	3.0	16.0	50					

\*1 : Self Resonant Frequency \*2 : DC Resistance

#### 4. Low DC resistance Type EA

■ Examples : Type 3225(1210)EA

Part No.	Inductance		Q min.	L , Q Test Freq.( MHz)	SRF *1 min.(MHz)	DCR *2 max.(Ω)	DC Current max.(mA)
	μH	Tolerance					
ELJEA1R0MF	1.0	±20 %	7	7.96	100	0.09	500
ELJEA1R5MF	1.5				80	0.10	390
ELJEA2R2MF	2.2				65	0.13	350
ELJEA3R3MF	3.3				50	0.16	270
ELJEA4R7MF	4.7				46	0.18	240
ELJEA6R8MF	6.8				36	0.25	200
ELJEA100KF	10	±10 %	10	2.52	29	0.34	160
ELJEA150KF	15				25	0.42	145
ELJEA220KF	22				18	0.65	115
ELJEA330KF	33				16	0.91	95
ELJEA470KF	47				13	1.30	80
ELJEA680KF	68		10	1.95	60		
ELJEA101KF	100		20	0.796	8.0	3.12	50
ELJEA151KF	150				7.0	4.03	45
ELJEA221KF	220				5.0	7.15	35
ELJEA331KF	330				4.0	9.23	30

\*1 : Self Resonant Frequency \*2 : DC Resistance

### ■ Dimensions in mm (not to scale)

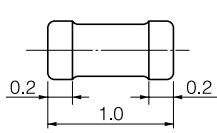

Type RF  
(1.0×0.5×0.5)

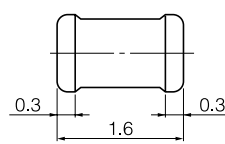
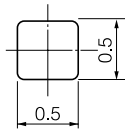

Type RE, PE  
(1.6×0.8×0.8)

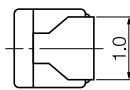
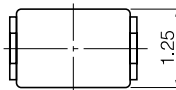
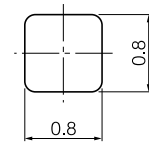

Type ND  
(2.0×1.25×1.25)

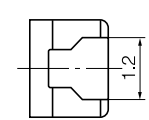
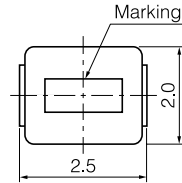
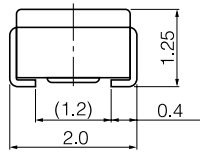

Types FC, NC, PC  
(2.5×2.0×1.6)

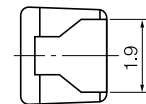
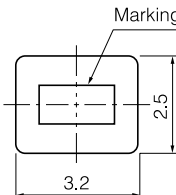
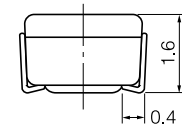

Types FA, SA, NA, PA, EA  
(3.2×2.5×2.2)

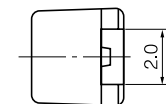
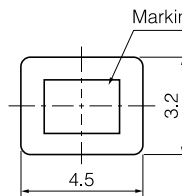
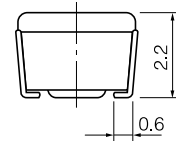

Type FB  
(4.5×3.2×3.2)

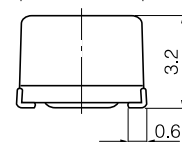

### ■ Recommended Land Pattern in mm (not to scale)

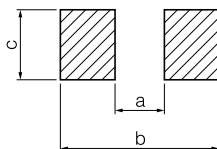

Type	a	b	c
RF	0.5~0.6	1.5~1.7	0.5~0.6
□E	0.8~1.0	2.0~2.6	0.7~0.9
ND	1.0~1.2	3.0~3.8	0.9~1.3
□C	1.4~1.5	3.5~4.0	1.2~1.6
□A	1.6~2.0	4.0~4.6	1.9~2.4
FB	2.4~2.6	5.5~6.0	2.0~3.0

□E: RE, PE   □C: NC, FC, PC   □A: NA, FA, SA, PA, EA

## ■ Paper Tape Dimensions in mm (not to scale)

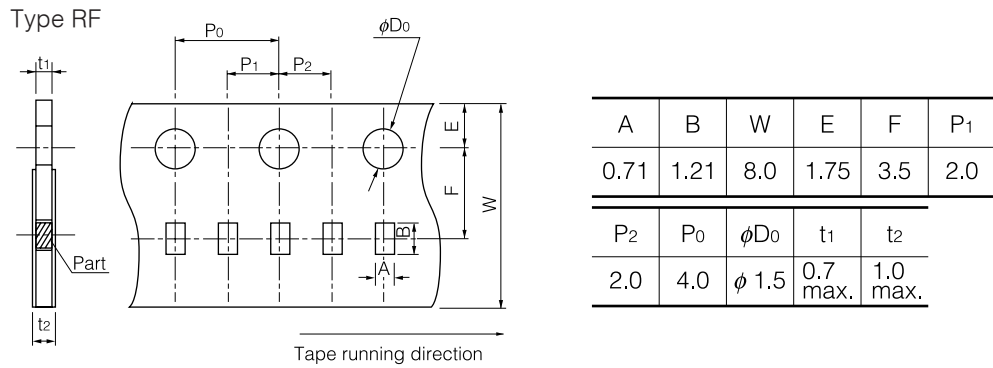

## ■ Embossed Carrier Tape Dimensions in mm (not to scale)

Types RE, PE, ND, NC, FC, PC (W=8 mm)

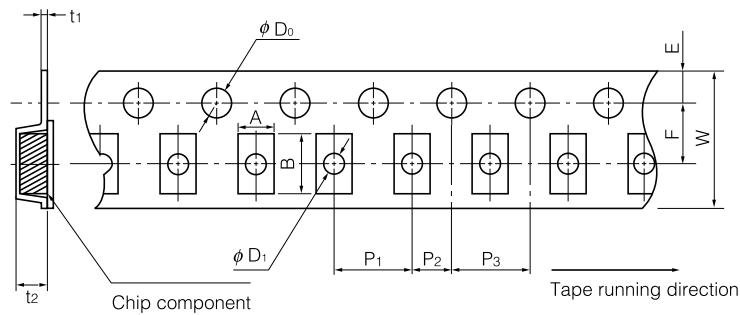

Types NA, FA, SA, PA, EA (W=8 mm)

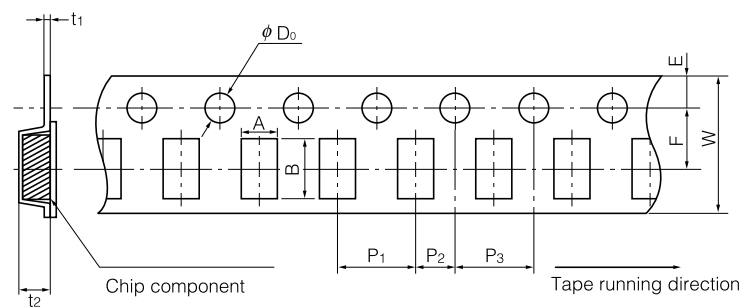

Type FB (W=12 mm)

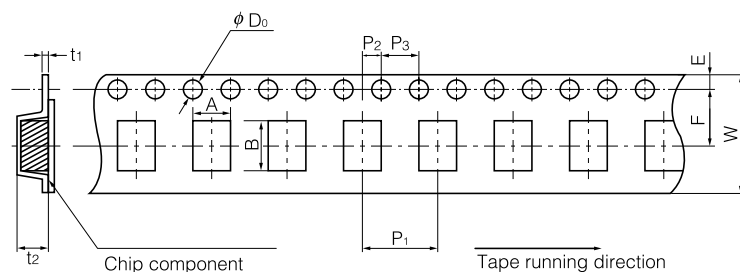

Size/Types		Dimensions											
		A	B	W	F	E	P <sub>1</sub>	P <sub>2</sub>	P <sub>3</sub>	φD <sub>0</sub>	φD <sub>1</sub>	t <sub>1</sub>	t <sub>2</sub>
1608(0603)	RE, PE	1.0	1.8	8	3.5	1.75	4.0	2.0	4.0	1.5	0.6	(0.27)	1.2
2012(0805)	ND	1.45	2.25	8	3.5	1.75	4.0	2.0	4.0	1.5	1.0	(0.25)	1.55
2520(1008)	NC, FC, PC	2.4	2.9	8	3.5	1.75	4.0	2.0	4.0	1.5	1.1	(0.25)	1.85
3225(1210)	NA, FA, SA, PA, EA	2.8	3.6	8	3.5	1.75	4.0	2.0	4.0	1.5	—	(0.25)	2.4
4532(1812)	FB	3.6	4.9	12	5.5	1.75	8.0	2.0	4.0	1.5	—	(0.3)	3.5

### ■ Packaging Methods

#### ● Standard Packing Quantity and Mass

Types	Quantity, Mass	
	Quantity	Mass (Weight) Approx.
RF	10000 pcs.	—
RE, PE, ND	3000 pcs.	90 g
NC, FC, PC	2000 pcs.	100 g
NA, FA, SA, PA, EA	2000 pcs.	170 g
FB	500 pcs.	100 g

### ■ Reel Dimensions in mm (not to scale)

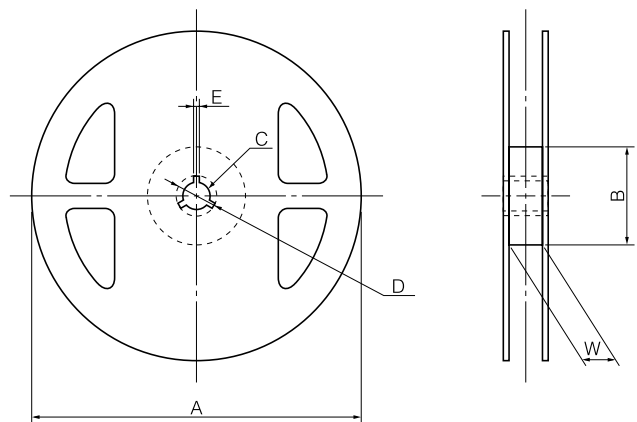

Types	Dimensions					
	A	B	C	D	E	W
RF	180	60	13	21	2	9
RE, PE, ND, NC, FC PC, NA, FA, SA, PA, EA	180	60	13	21	2	9
FB	180	60	13	21	2	13

## Cautions for use

For securing upgraded reliability and safety, consider following caution items.

### 1. Land pattern design

Refer to the recommended land dimensions of each type at flow and reflow solderings.

Avoid placing the chip inductor on any metal pattern except the land because the drop of Q and mutual conductance may occur.

Provisions for venting of flux gases should be made for high density assemblies.

### 2. Mounting

Placement force should not exceed 20N because electric and magnetic characteristics change by applying strong force.

### 3. Soldering

#### a) Flow soldering

Recommended conditions; 260 °C max., 5sec. max.(total time at 2 waves method)

#### b) Reflow soldering

##### ① Infra-red reflow soldering

Recommended conditions: 200 °C or high at electrode, 60sec. max. and peak 250 °C max., 5sec. max.

If the solder at the two electrodes are not melt simultaneously, the chip inductor may not be mounted on the right place.

It is recommended to fix by adhesive when the deviation is great.

##### ② VPS reflow soldering

Recommended conditions: 215±5 °C, 20 to 60sec.

### 4. Cleaning

① Do not use acid or alkali agents. Some cleaning solvents out of CFC may damage the products. Confirm the reliability in advance.

② If ultrasonic cleaning is employed, please inform us immediately for technical consultation.

### 5. Instructions for applying current

The rated current is defined as the smaller value of either the current value when the inductance drops 10 % down from the initial point, or the current value when the average temperature of coil inside rises 20 K up from initial point.

Do not operate this coils beyond the specified rated current.

### 6. Storage

① Be careful a high temperature, a large amount of moisture, gases and magnetic field.

② At long storage of more than 1 year, use the products after inspecting the outer structure